



MICHIGAN'S 2022 Roads & Bridges ANNUAL REPORT





Rob
Suhner

Ryan
Buck

Michelle
Kavanaugh



Dear Reader,

On behalf of the Michigan Transportation Asset Management Council (TAMC) it is our pleasure to provide the 2022 Roads and Bridges Annual Report highlighting our 20 years of leaders in asset management.

The TAMC was formed under Public Act (PA) 499 of 202, as amended, to promote the use of asset management practices among Michigan's road owning agencies. Our mission over 20 years has evolved to include our coordinated effort with the Michigan Infrastructure Council (MIC) and the Water Asset Management Council (WAMC) as together we develop a statewide asset management strategy.

We want to thank each and every person and entity who assisted in building the foundation of the TAMC over the years. To all those who served on the TAMC and supporting administration team, we thank you for paving the way for us today and your vision in asset management. We have been successful thanks to the many road owning agencies who have collected an overwhelming amount of data and created useful information for data driven decision making and public education.

There are so many who now recognize pavement surface evaluation and rating (PASER). Many awards have been provided showcasing the implementation of asset management best practices.

We are sincerely grateful for all those who participated in training, the PASER data collection, inventory-based rating (IBR) gravel road data collection, transportation asset management plan (TAMP) submittals, investment reporting tool information, culvert data collection and any investments made on behalf of the TAMC over 20 years. Please continue to participate in training and use our dashboards to visually showcase your work.

We encourage you to provide nominations in the future for TAMC awards, so together we can celebrate your efforts.

I want to thank our current TAMC members who will continue to lead our asset management efforts statewide and thank you to each of their representing organizations for continued support.

If you have any questions, please contact either me or the TAMC Coordinator at ***MDOT_TAMC@michigan.gov***

Sincerely,

A handwritten signature in black ink that reads "Joanna I. Johnson". The signature is written in a cursive, flowing style with a large initial 'J'.

Joanna I. Johnson, TAMC Chair

MAJOR TAKEAWAYS FROM 2022

Education and Training – 2022 marked 20 years of TAMC and the first in person conference since 2019 celebrating this milestone. We continued virtual training with added interest in culvert asset management.
(See 2022 Year in Review)

Roads – Conditions maintained the gains in 2021. A successful year with the most non-federal-aid lane miles ever rated.
(See 2022 Road Condition)

Investment Reporting – Michigan ranks near the top in Asset Management practices nationwide. Project information from the 617 road agencies used to assist condition forecasts.
(See Investment Reporting)

Bridges – Conditions continue to decline. Added concern on local road agency bridges - 69 bridges were closed in 2022 due to their poor condition.
(See 2022 Bridge Condition)

2022 Federal-Aid Pavement Condition

Percent Lane Miles

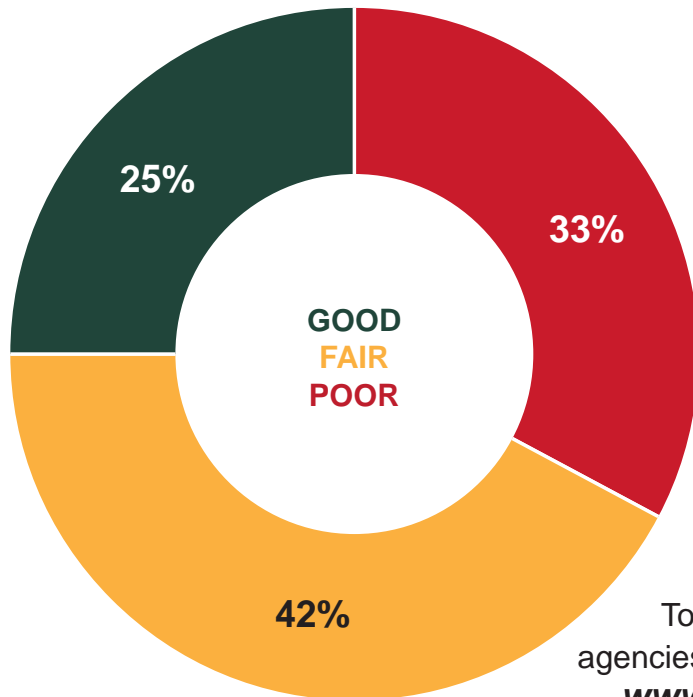

2022 Bridge Condition

All Roadway Bridges

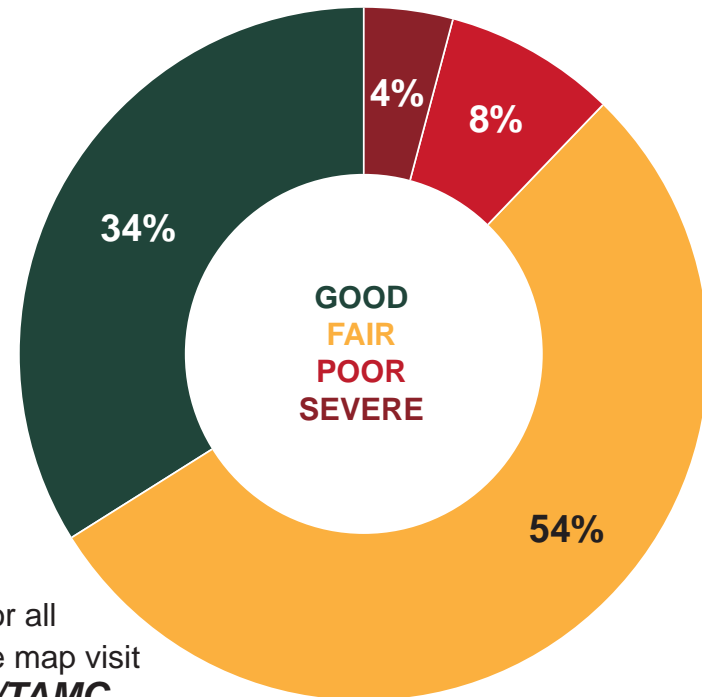

To see dashboards for all agencies and an interactive map visit www.Michigan.gov/TAMC

TRANSPORTATION ASSET MANAGEMENT COUNCIL (TAMC)



To develop and support excellence in managing Michigan's transportation assets by:

- Advising the Legislature, the Michigan Infrastructure Council (MIC), State Transportation Commission, and transportation committees.
- Promote asset management principles.
- Provide tools and practices for road agencies.
- Collaborate and coordinate with the Water Asset Management Council (WAMC).

TAMC members for 2022 and the organizations they represent:

- Joanna I. Johnson (TAMC Chair)**, County Road Association of Michigan
William McEntee (TAMC Vice-Chair), County Road Association of Michigan
Ryan Buck, Michigan Transportation Planning Association
Arthur J. Green, P.E., Michigan Department of Transportation
Robert Green, P.E., Michigan Department of Transportation
Jacob Hurt, Michigan Association of Regions
James Hurt, Michigan Municipal League
Kelly R. Jones, P.E., Michigan Association of Counties
Robert Slattery Jr., Michigan Municipal League
Rob Surber, Michigan Department of Technology, Management and Budget (Non-Voting)
Jennifer Tubbs, Michigan Townships Association

For added background on TAMC, its members and its related legislation, please visit the *About Us* section on the TAMC website at:

www.Michigan.gov/TAMC

Special Thanks:

CSS

John Clark
 Cheryl Granger
 Jeri Kaminski
 Courtney Peterson
 Thomas Ro
 Guna Sekhar Javvadi

MDOT

Jacob Armour
 Rebecca Bramblett
 Keith Cooper
 Eric Costa
 Rob Green
 Mike Halloran
 Charles Jarvis
 Dave Jennett
 Laura Loomis
 Matt Moulton
 Gloria Strong

MTU

Scott Bershing
 Tim Colling
 Chris Gilbertson
 Pete Torola

TABLE OF CONTENTS

2022 Year in Review.....	1
TAMC Highlights and Accomplishments	
Training, Work Program, Budget Overview	
Transportation Asset Management Plans (TAMPs)	
Website, Interactive Map, Dashboards and Other Data Efforts	
2022 Road Condition.....	7
Condition Trend 2013-2022	
Paved Federal-Aid Condition	
Paved Non-Federal-Aid Condition	
Pavement Condition Forecast	
Gravel Roads & Inventory Based Rating (IBR)	
2022 Bridge Condition.....	15
Condition Trend 2013-2022	
Comparing Bridge Conditions	
MDOT Bridge Condition	
Local Road Agency Bridge Condition	
Bridge Cycle of Life	
Bridge Condition Forecast	
Investment Reporting.....	23
Traffic Signal Inventory Survey	
Road Project Details	
Bridge Project Details	
Michigan and Local Road Asset Management Across the Country	
Celebrating 20 Years of TAMC.....	31

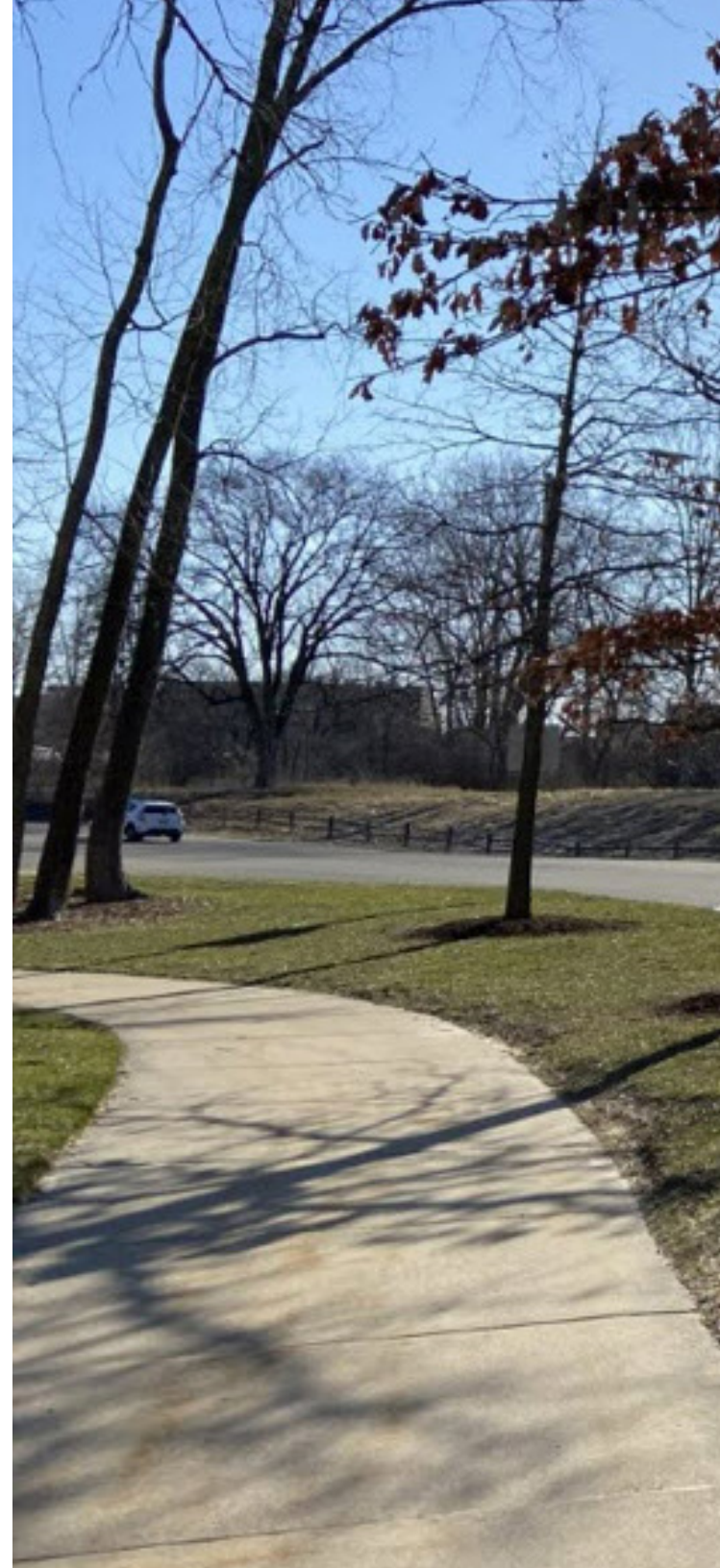



2022 YEAR IN REVIEW



TAMC Highlights and Accomplishments

Below is a list of 2022 highlights and accomplishments, with added details spread throughout this report.

- Hosted “20 Years of Celebrating TAMC” Conference.
- Increased participation in asset management training for local officials and culvert trainings.
- Updated road condition and culvert condition data collection policies.
- Used IRT bridge projects in the bridge condition forecast.
- Added the Severe category to TAMC bridge condition dashboards and interactive map.
- Recorded the highest accuracy of PASER road condition data in 20 years.
- Collected the most non-federal-aid lane miles of road condition data in 20 years.
- Over 290 road agencies collected road condition data on 90% of their federal-aid lane miles.
- Over 9,000 road and bridge improvement projects reported by road agencies. (2021/2022)

To learn more on TAMC Policies, Dashboards and Interactive Map:

TAMC Policies

TAMC Dashboards

TAMC Interactive Map (IMAP)

Grateful For Your Service

TAMC would like to sincerely thank the following TAMC Members for their service, commitment and dedication to the TAMC and its various committees and program areas:

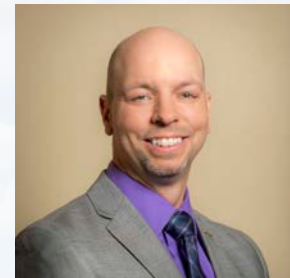

Robert Green, P.E.

Transportation Asset Management Section Manager, representing the Michigan Department of Transportation (MDOT) served the TAMC from July 2022 through March 2023.



Gary Mekjian, P.E.

Assistant Director of the City of Farmington Hills, representing the Michigan Municipal League (MML) served the TAMC from January 2017 through June 2022.



Todd White

Director of the Bureau of Planning, representing the Michigan Department of Transportation (MDOT) served the TAMC from October 2018 through June 2022.



Bradley C. Wieferich, P.E.

Acting Director, representing the Michigan Department of Transportation (MDOT) served the TAMC from June 2015 through October 2022.



TAMC Conference – “20 Years of Celebrating TAMC”

For the first time since 2019, TAMC was able to hold an on-site conference. This was special in another way as the 2022 Conference also marked 20 years of TAMC! This exciting event gave an opportunity for current professionals and those experienced veterans to gather and reflect on how TAMC has grown since its initial creation in 2002 by PA 325 and continued to lead in education, training



and partnerships in data driven decision making. From the initial PASER data collection pilot to the extensive array of Dashboards and Interactive Maps, TAMC has indeed come a long way. The conference featured current and former TAMC Chairs and members along with past TAMC award winners to see where they are today. This event included added collaboration with the MIC and

FHWA as TAMC reflected on its past journeys and looks ahead to future ones.

Details of the event and recordings for each presentation are available on the Center for Technology and Training Website.

2022 TAMC 20-Year Celebration and Conference



Culvert Asset Management Program

Agencies continued culvert data collection efforts in 2022, with enhancements to the tools and training. Large road agencies are required to report on these culvert assets as part of Public Act (PA) 325 of 2018 where smaller agencies recognize culverts as critical pieces of infrastructure. To assist in these efforts, TAMC created the **Policy for Collection of Culvert Inventory and Condition Data** that was updated in January 2023. This update focuses on technology being developed to aggregate culvert data statewide like the provisional data in the 2018 culvert pilot.

The majority of these provisional data sets were culverts under 10 feet diameter and in most cases less than 2 feet. This information can be seen on the TAMC Interactive Map and Dashboard.

TAMC Culvert Provisional Data Dashboard

MTU/CTT - Training Programs	Number of Training Events	Number of Participants
TAMC Conference	1	111
PASER Training	8	362
Transportation Asset Management and Gravel Road Basics for Local Officials	5	184
Bridge AM Training Series Workshop	2	20
IBR System™ Training	3	148
Pavement AMP Workshop	2	27
Culvert AM Webinar	3	113
Compliance Plan Training Webinar	2	23
<i>Figures provided by MTU's 2022 Training Report</i>	Total:	26
		988

Figure 1

Source: TAMC 2022

DTMB/CSS - Training Programs	Number of Training Events	Number of Participants
IRT Training	6 webinars	162

Training, Work Program and Budget Overview

TAMC trainings in 2022 included both on-site sessions and continued virtual format trainings for greater access. Figure 1 shows the numerous trainings and outreach efforts that are defined in the TAMC strategic work program. Asset management for local officials and culverts both increased participation from 2021. TAMC FY2022 Budget is shown in Figure 2 with a breakdown of all area expenses. *Note: Administrative staff is provided by MDOT and not included in the TAMC budget.*

TAMC Strategic Work Program

FY2022 Budget Overview	
Regional Program and Data Collection	\$1,116,400
Central Data Agency and Technology	\$380,000
Training and Educational Activities	\$350,000
Council Expenses	\$30,000
Total:	\$1,876,400

Figure 2

Source: TAMC 2022





Transportation Asset Management Plans (TAMPs)

Legislation from PA 325 of 2018, requires local road agencies with 100 or more miles of certified roads to submit a TAMP. These comprehensive plans provide local road agencies greater insight into their inventory of assets and future needs.

TAMP required elements include:

1. Asset Inventory (roads, bridges culverts, and signals)
2. Performance Goals
3. Risk of Failure Analysis
4. Anticipated Revenue and Expenditures
5. Performance Outcomes
6. Coordination Clause
7. Proof of Adoption by Governing Body

TAMC has created resources and training opportunities to assist local road agencies including a template that utilizes the agencies' previous data collection efforts and dashboard summaries.

There are over 123 road agencies that are striving to meet these legislative requirements. As of April 2023, 73% of the TAMPs have been received from the first submissions covering October 1, 2020, to October 1, 2022. Updates to the TAMPs are due every three (3) years on the schedule prescribed by the TAMC Policy for the Submittal and Review of Asset Management Plans for Roads, Bridges and Transportation Infrastructure. A list of approved TAMPs can be found on the TAMC website and is updated on a bi-annual basis. (*PA 325 Approved TAMPs*)

On the horizon are two additional components of the PA 325 of 2018 legislation:

Oct 1, 2024 – TAMC will notify local road agencies if they are not striving toward their condition goals.

Oct 1, 2025 – TAMC shall provide notice to the local road agency of the reasons that it has determined progress is not being made.

TAMC will be working hand in hand with road agencies to meet their TAMP plan elements as described in their TAMP submissions.

To learn more on TAMPs, PA 325 and training opportunities:

TAMC Resources & Public Act 325

TAMP FAQs

Training

Asset Management Plan Templates

Michigan Largest 123 Road Agencies Map



Website, Interactive Map, Dashboards, and Other Data Efforts

The TAMC website was extensively updated in 2022 with new technology and requirements for all State of Michigan websites. The new site is now better aligned and redesigned with its sister councils to represent the collaboration of asset management with the MIC, TAMC and WAMC and provides information on training, policies, conferences, and data efforts.

One of TAMC's main charges is providing easy access to the conditions of roads and bridges and other performance metrics. These rely heavily on the reporting and data collection efforts of 617 road owning agencies across the state.

The TAMC Interactive Map and Dashboards display data for Roads, Bridges, and Culverts conditions along with Finance, Traffic, Maintenance and Safety data. These data sets can be displayed statewide, regionally, by city, village, county and legislative districts. A milestone feature added in 2023 is the breakout of the Severe category for bridge conditions. This easily shows those bridges across the state that represent the most at risk for potential future closures if not addressed with more information in the Bridge Conditions section.

Other data efforts include ongoing culvert inventory and IBR (Inventory Based Rating) for gravel road conditions detailed further in the **Road Condition** section of this report. A new statewide traffic signal inventory reporting effort is also highlighted in the **Investment Reporting** section.

To view the website, Interactive Map and Dashboards, visit the TAMC website: [**www.michigan.gov/TAMC**](http://www.michigan.gov/TAMC)

Signup for TAMC email notifications: **TAMC sign up for notifications (Gov. Delivery Email List Serve)**

2022 ROAD CONDITION



One of TAMC's main charges is to determine the condition of paved federal-aid roads, which account for 1/3 of Michigan roads and carries over 95% of the traffic. Beginning in 2003, MDOT, county, regional, and metropolitan planning agencies joined together to pursue this statewide effort. Under the direction of TAMC, PASER is the measure chosen to identify the condition of pavements and for 20 years has been a consistent, reliable data source.

PASER Condition Ratings		
8-10	Good Condition	Routine maintenance candidate.
5-7	Fair Condition	Preventative maintenance or rehabilitation candidate.
1-4	Poor Condition	Rehabilitation or reconstruction candidate.

In looking at the trend graph in Figure 3, the 2022 roads conditions almost remained the same with approximately 25% of all paved federal-aid roads being in the Good condition category. This is a positive sign as road conditions did not deteriorate substantially from the significant gains in 2021.

However, this trend is not expected to continue as paved federal-aid roads are expected to deteriorate, outpacing the potential funding available to maintain the network. See the **Pavement Condition Forecast** section for more details.

Paved Federal-Aid Road Condition

2013-2022

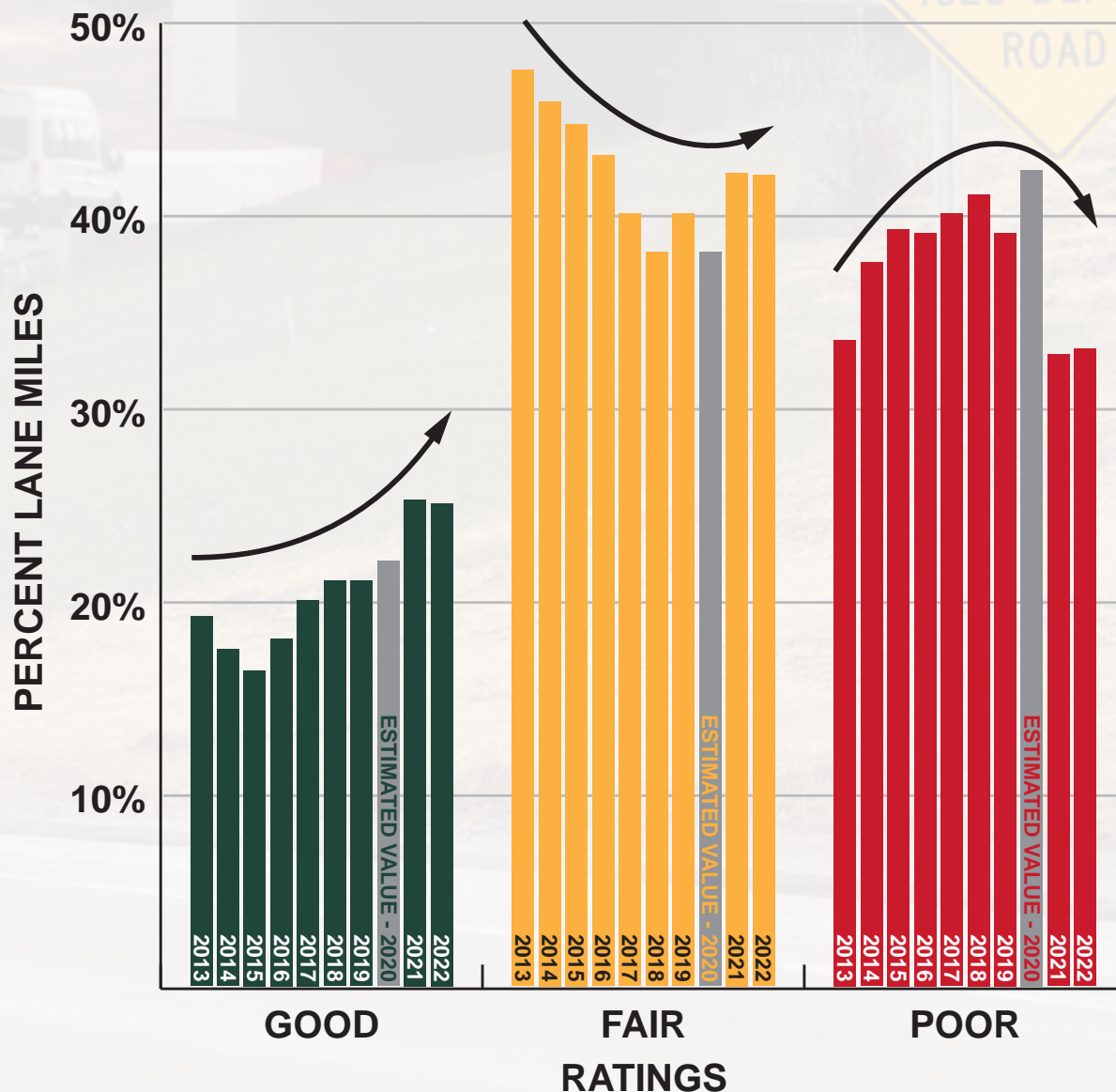

Figure 3

Source: 2013-2022 PASER Data Collection

2022 Federal-Aid Pavement Condition

Percent Lane Miles

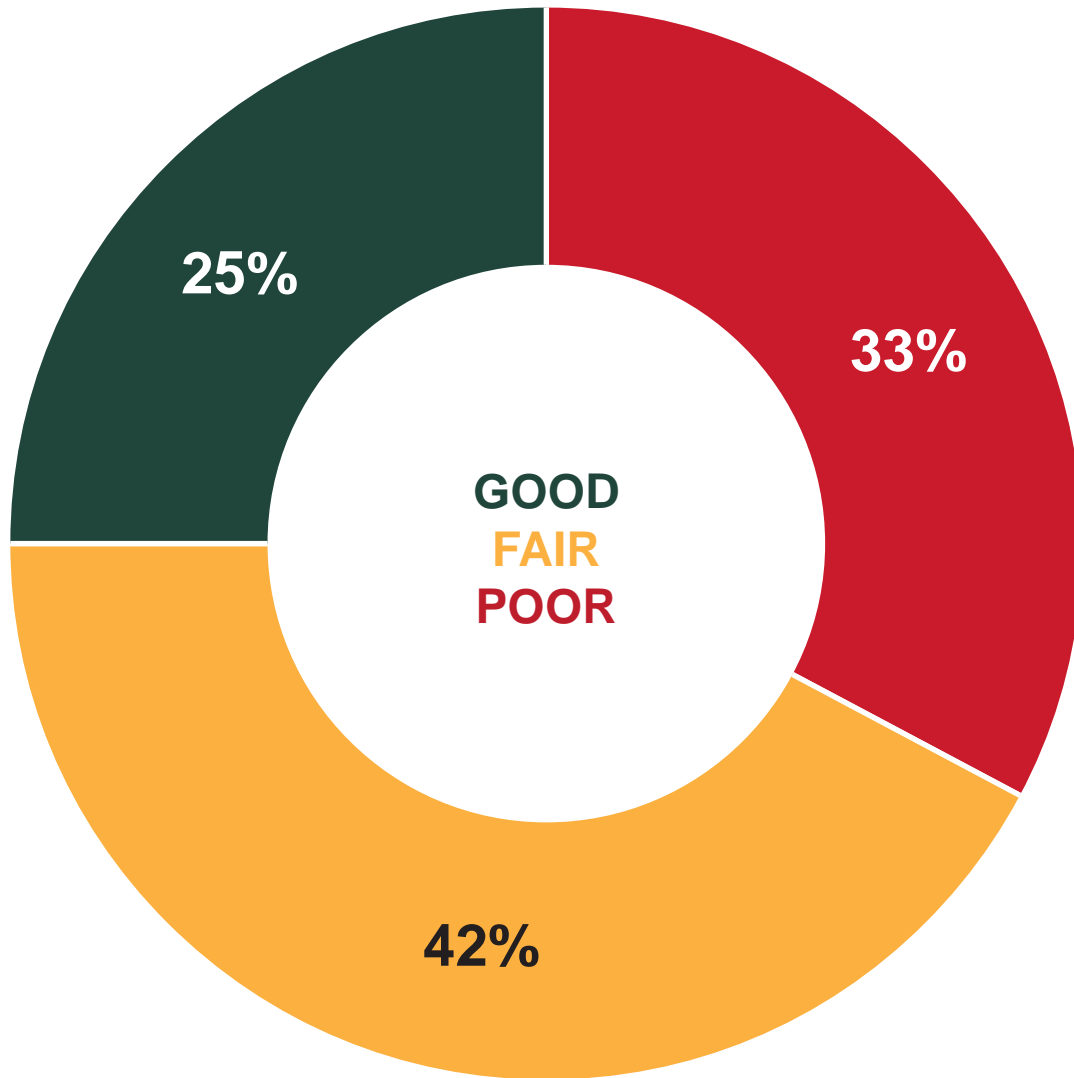

Figure 4

Source: 2022 PASER Data Collection

Figure 5

Source: 2022 PASER Data



Paved Federal-Aid Roads

Road agencies report on the condition of all paved federal-aid roads over the course of two years. Figure 5 is a map showing roads rated in 2021 and 2022. About 60% of the 88,000 lane miles were collected in 2022 and the remaining 40% were used from the 2021 data collection.

In 2021 nearly the entire network was rated to make up for 2020 when data collection was not possible due to COVID-19 restrictions. Over 290 agencies collected 90% or more of their data again in 2022, indicating the value of this inventory effort in data-driven decision making.

Figure 4 shows a composite of these data collection efforts with 33% of Michigan's lane miles still in poor condition.

Figure 6

Source: 2022 PASER Data

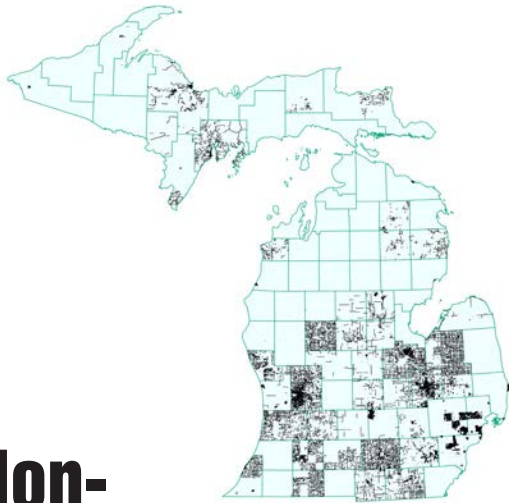

Non-Federal-Aid Roads

There are over 165,000 lane miles of non-federal-aid (NFA) roads in Michigan. The federal government classifies these roads as being “local roads.” Each year, many local road agencies choose to rate some or all of their NFA roads.

In 2022, the most NFA roads were rated at 26,090 lane miles. Figure 6 shows a map of these ratings collected by 312 local agencies. Of these roads, 45% were found to be in poor condition as seen in Figure 7 which was also similar to 2021.

Local road agencies use ratings on both federal-aid and NFA roads to help manage their road network. TAMC continues to look at ways to bring smaller agencies into the mix that may never have had ratings on their local NFA roads.

2022 Non-Federal-Aid Road Condition

Percent Lane Miles

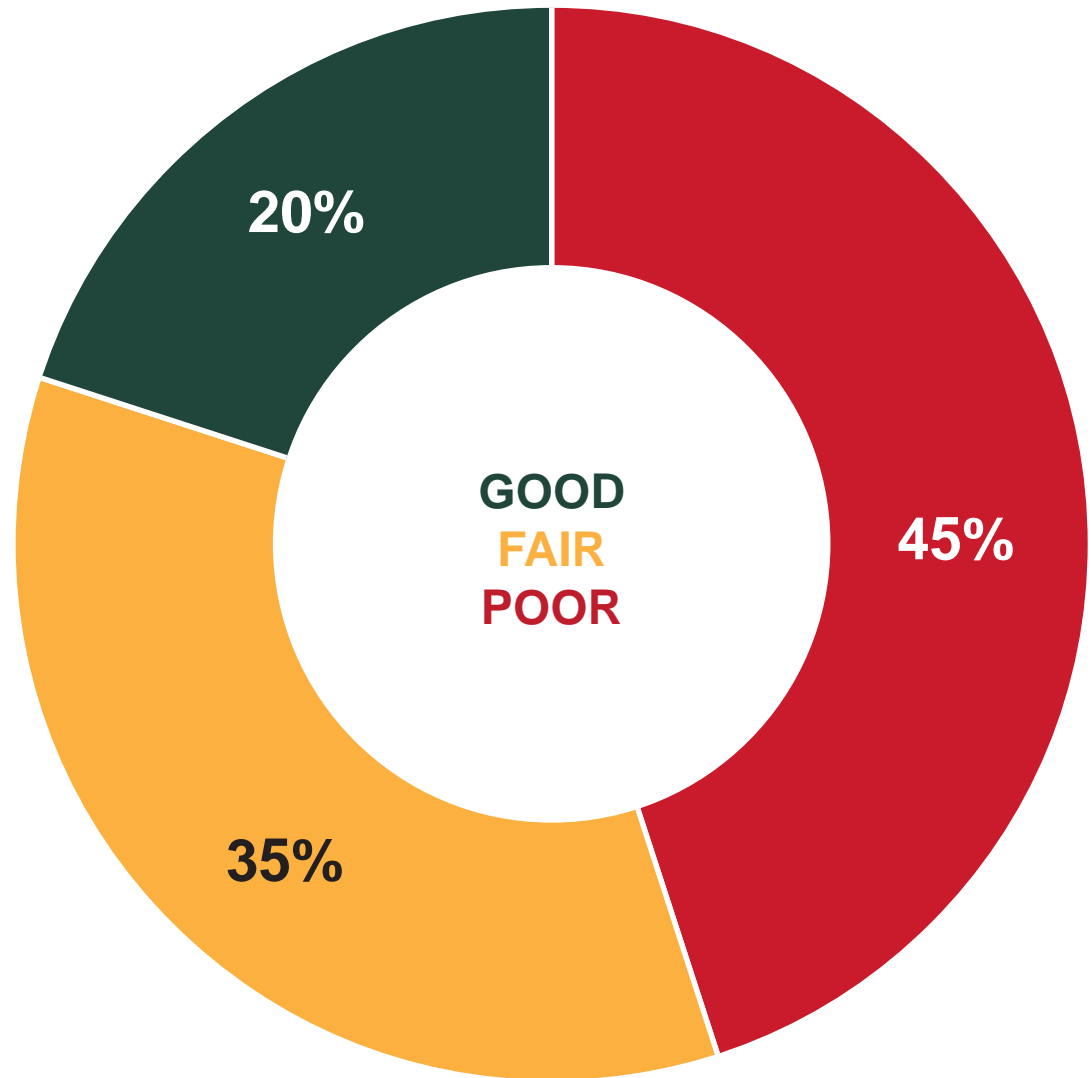

Figure 7

Source: 2022 PASER Data Collection

Pavement Condition Forecast

Approach for 2024-2034

The Pavement Condition Forecasting System (PCFS) estimates the future condition of pavements. Examples of criteria that support the PCFS include current pavement condition, road deterioration rates, project costs, expected inflation, fix strategies, and revenues. The forecast also takes into consideration that regions across the state have different challenges when it comes to road repairs and improvements. Data from the Investment Reporting Tool (IRT) was used to determine varying treatment type costs more accurately across the state. (See Investment Reporting Section)

Factors that affect the repairs and improvement costs are:

- Size of the project
- Where it is located
- Impact of frost freeze levels
- Exposure to extreme heat
- Traffic volume

All these factors can cause stress to pavement and requires the pavement be constructed and maintained according to its location.

Using these regionally based treatment type costs, individual regional forecasts were developed for 2024-2034. These forecasts were then combined to predict the future condition of pavements across the state.

The statewide pavement forecast indicates a continued decline in the federal-aid roads as seen in Figure 8. By 2034, it is forecast that only 19% of the roads will be in good condition while roads in fair condition will drop to 33%. Over those 10 years the roads in poor condition will reach 48%.

Similar to last year's forecast, this is primarily due to the increase in costly reconstruction projects initiated when additional monies such as the COVID Relief Act and Infrastructure Investment and Jobs Act (IIJA) are available. This money targets the poorest of pavement but inevitably results in less lane miles being completed.

The increased cost for pavement fixes also contributes to less pavement being improved. Without additional and consistent long-term investment in the billions of dollars, the percent of roads in poor condition will continue to increase, as the increasing construction cost outpaces the ability to fix them.

For 2022 TAMC continued the path of two-member rating teams to assist agencies as resources continue to be stretched. The commitment of these rating teams is significant as 2022 resulted in the highest quality review with less than 1/8 rating point difference with the quality control teams.





Pavement Condition Forecast

2024-2034

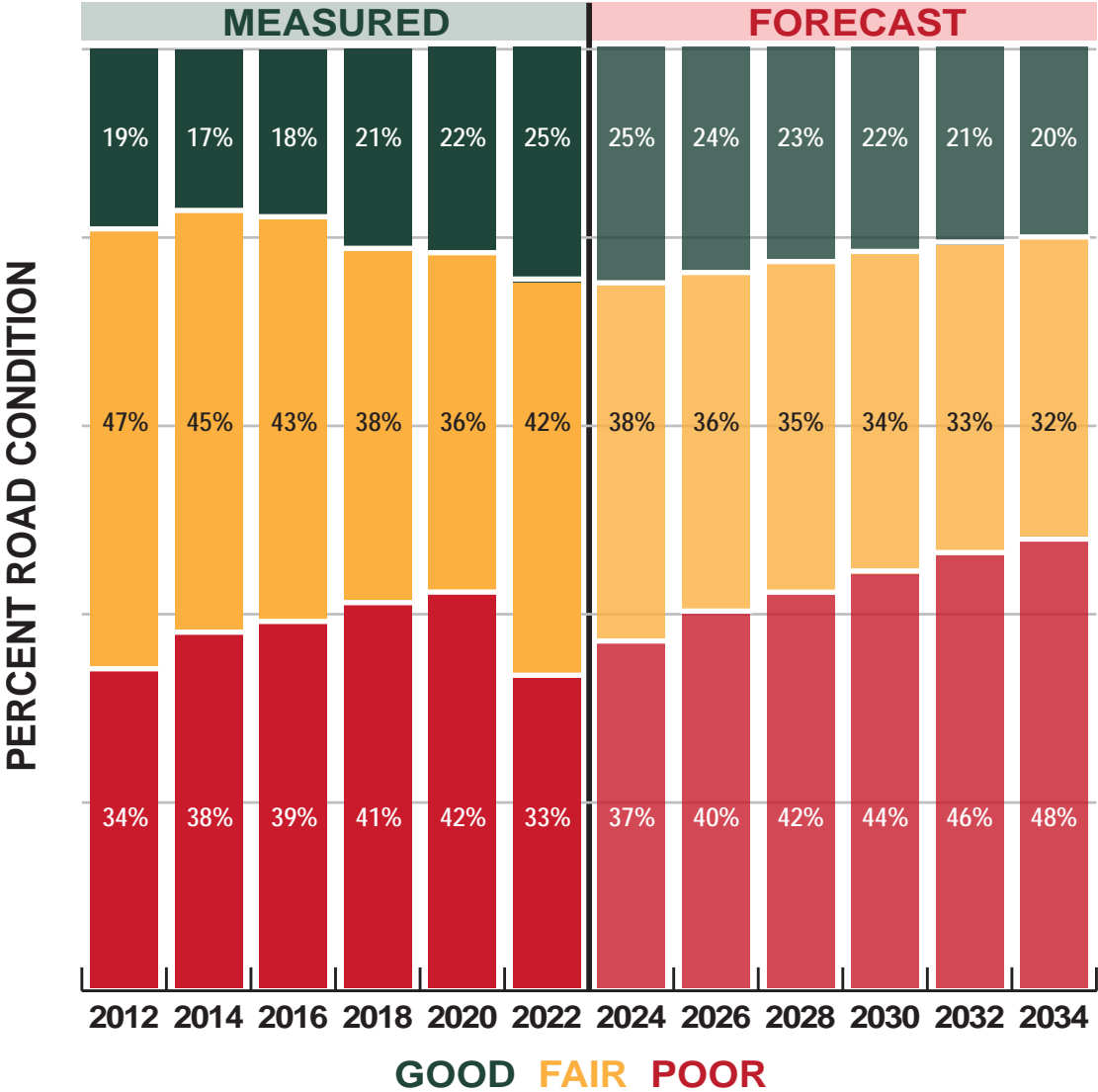

Figure 8

Source: 2022 TAMC

Gravel Roads & Inventory Based Rating (IBR)

In 2018, gravel roads IBR was introduced. This is a similar effort to PASER on paved roads with supported training by TAMC based on a 0-9 rating scale. See example IBR numbers on page 14. The IBR rating system provides added tools to manage this important and often missed element of Michigan's road infrastructure.

Figure 9 shows the total miles of IBR ratings collected on gravel roads from 2018-2022. These IBR ratings on gravel roads peaked in 2021 with close to 4500 lane miles of ratings.

Some road agencies make the decision to return a paved road back to a gravel road. This is often due to costs but also

for level of service considerations as another form of asset management in balancing the total road network.

Note: Teams collecting PASER ratings for paved roads, can have the added training to collect IBR for gravel roads in their system.

To learn more on IBR and gravel road condition ratings:

<https://ctt.mtu.edu/inventory-based-rating-system>

<https://ctt.mtu.edu/sites/default/files/resources/ibr-system/ibrmanual.pdf>

<http://www.ctt.mtu.edu/sites/ctt/files/flyers/2023paseribr.pdf>

Miles of Gravel Roads IBR Ratings

2018-2022

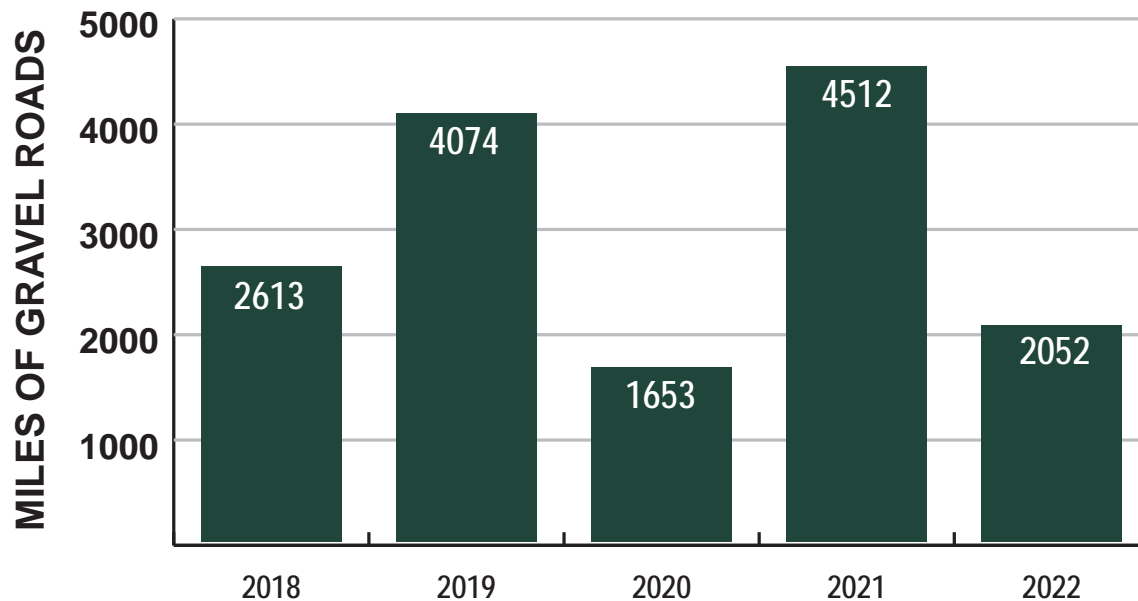
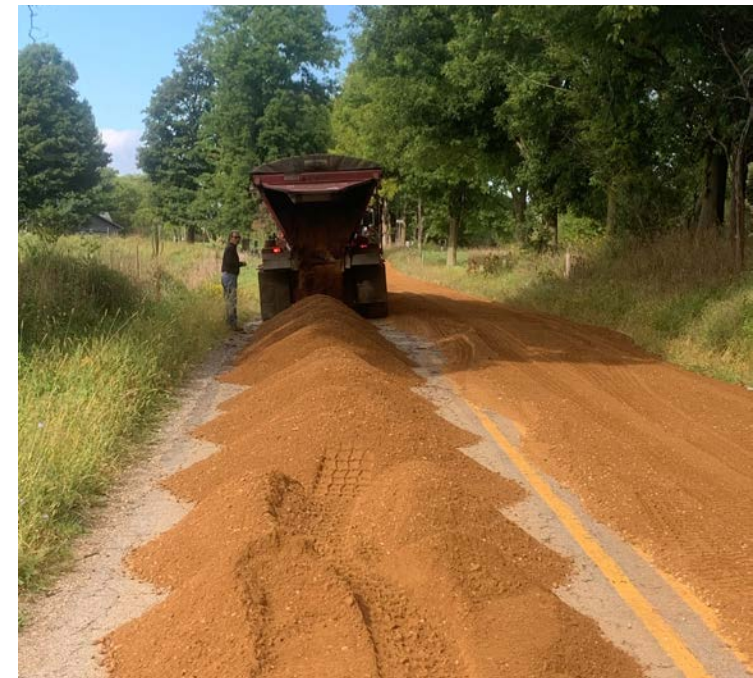

Figure 9

Source: 2018-2022 IBR Data Collection



Road Examples of IBR Numbers

9

IBR NUMBER 9

Surface Width: **Good**

Drainage Adequacy: **Fair**

Structural Adequacy: **Good**



8

IBR NUMBER 8

Surface Width: **Fair**

Drainage Adequacy: **Good**

Structural Adequacy: **Good**



5

IBR NUMBER 5

Surface Width: **Good**

Drainage Adequacy: **Poor**

Structural Adequacy: **Poor**



5

IBR NUMBER 5

Surface Width: **Poor**

Drainage Adequacy: **Good**

Structural Adequacy: **Good**



2022 BRIDGE CONDITION



The National Bridge Inspection Standards (NBIS) define a bridge as a structure carrying traffic with a span greater than 20 feet. Condition ratings are based on a 0-9 scale and assigned for each culvert, or the deck, superstructure, and substructure of each bridge. These ratings are recorded in the National Bridge Inventory (NBI) database.

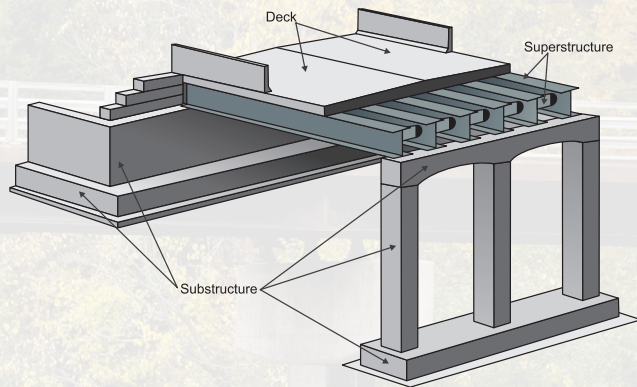

As shown in Figure 10, in 2022 over 11.3% of NBI structures in Michigan are in poor condition. This means that 1274 bridges need major rehabilitation or are candidates for replacement.

Since 2014 there has been a steady decline of bridges in good condition and a rise of bridges in fair condition. These trend lines indicate the continued statewide deterioration of bridges and the significant need for increased investment.

Statewide Bridge Condition

All Roadway Bridges 2013-2022

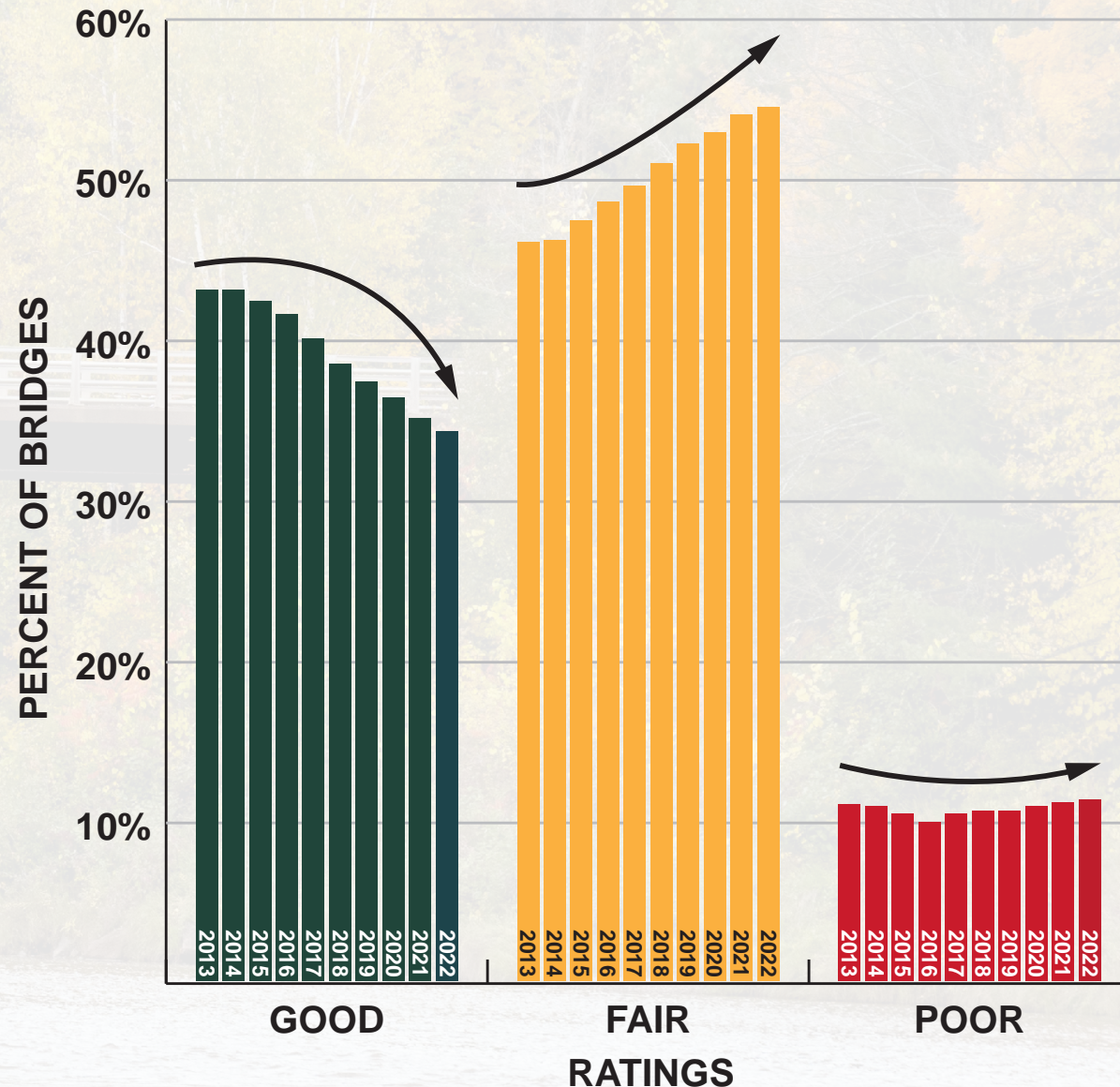

Figure 10

Source: 2013-2022 Michigan Bridge Inventory



Comparing Bridge Condition

Michigan lags behind its neighboring Great Lakes States in terms of bridge condition. As seen in Figure 11, Michigan has the highest percentage of poor bridges in the Great Lakes Region, and also has significantly more poor bridges than the national average. More concerning, when measuring the bridges in severe condition, or those requiring additional monitoring, immediate action, or at risk of closure, Michigan has double the percentage of bridges with NBI ratings of 3 or less.

NBI Condition Ratings		
7-9	Good Condition	Routine maintenance candidate.
5-6	Fair Condition	Preventative maintenance or minor rehabilitation candidate.
4	Poor Condition	Major rehabilitation or replacement candidate.
2-3	Severe Condition	Serious or Critical Condition
0-1	Imminent Failure or Failed	Major rehabilitation or replacement candidate. Bridge is closed to traffic.

2022 Percent Poor Bridges

NBI 4 or Less

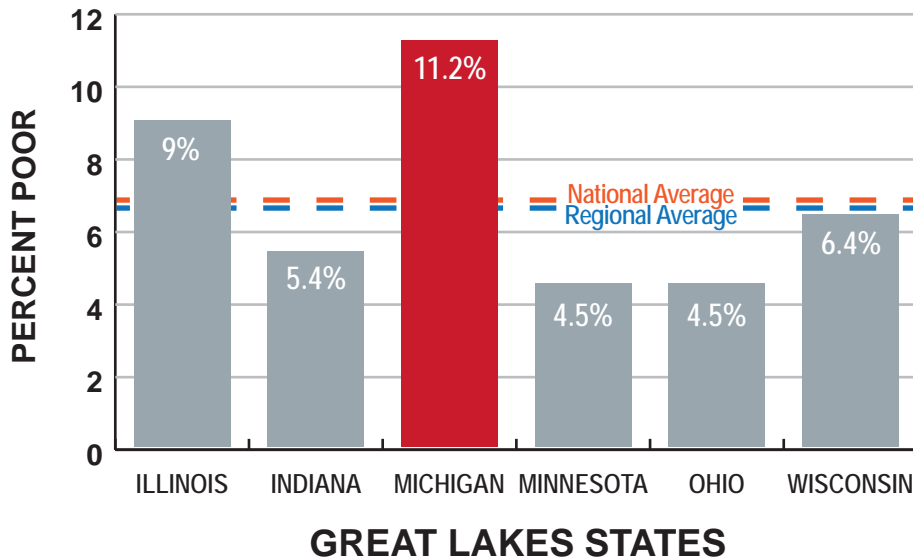

2022 Percent Severe Bridges

NBI 3 or Less

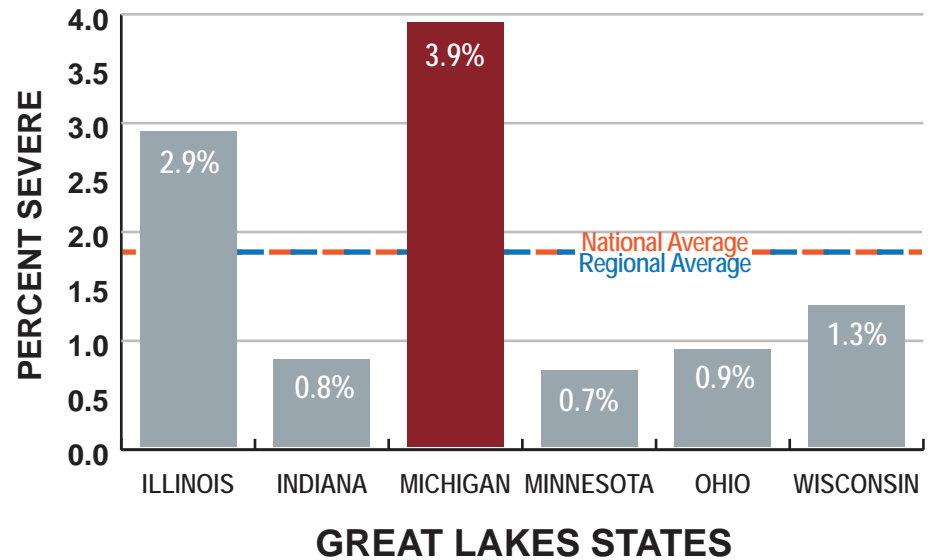

Figure 11

Source: 2022 Michigan Bridge Inventory

MDOT Bridges

Unlike roads, all bridges are considered federal-aid eligible. Figure 12 shows that MDOT has nearly 7% of its bridges in poor or severe condition and 69% of bridges are in fair condition. This large population of bridges in fair condition represents the previous investments in preservation. Until recently, MDOT has been able to maintain the number of bridges in fair condition before they reach the poor category, while increasing the number of bridges in good and fair condition. An aging infrastructure and rising costs along with not enough existing revenue or new revenue to maintain our aging bridges, have reversed some of that progress.

The number of bridges in fair condition has increased, and since 2017 the number of bridges in poor condition has increased as preservation needs exceed available revenues. Maintaining or improving the bridges rated in good or fair condition is imperative to prevent the number of bridges in the poor category from increasing further.

2022 MDOT Bridge Condition

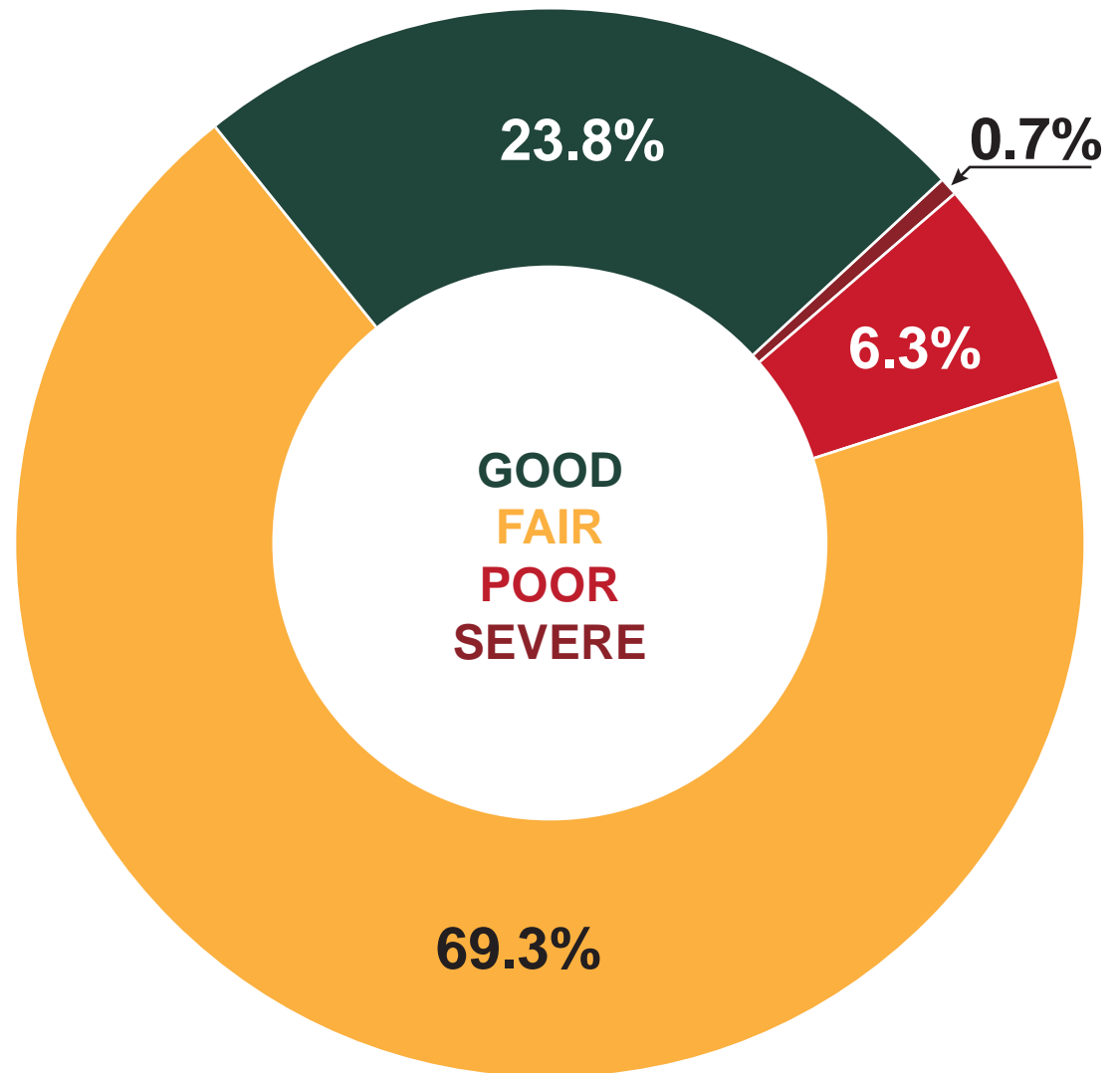
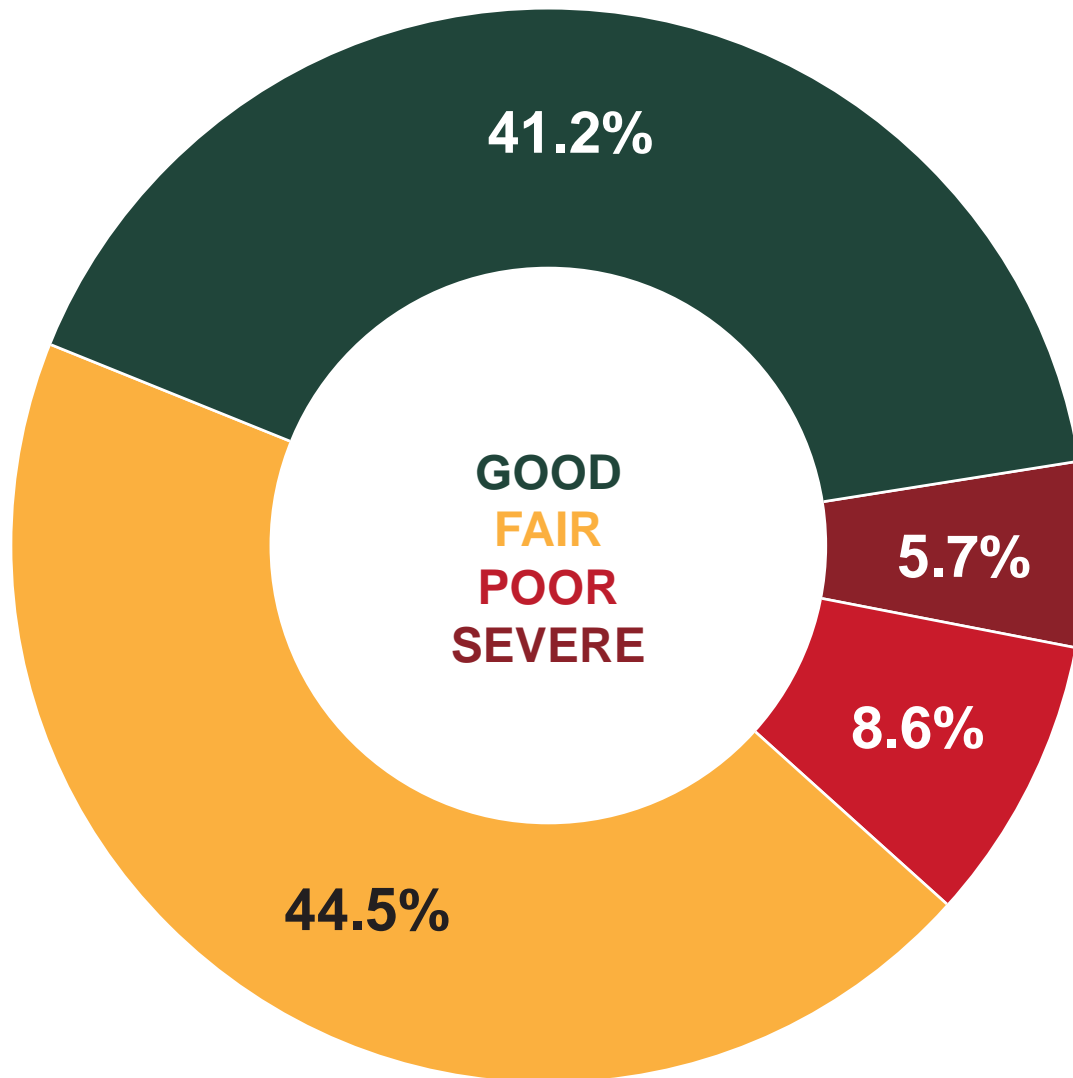

Figure 12

Source: 2022 Michigan Bridge Inventory

2022 Local Road Agency Bridge Condition



Local Road Agency Bridges

Figure 13 shows that local road agencies are managing both a larger percentage of good bridges, while also managing a larger percentage of poor and severe bridges. Many local road agencies are working to embrace preservation strategies but are prevented by the overwhelming need of the bridges in the worst conditions.

A bridge in poor condition is a candidate for major rehabilitation or replacement. When the bridge no longer has the strength to bear the loads for which it was designed, the bridge must be posted for lower loads in order to maintain safety.

A bridge in severe condition often needs expensive emergency repairs, temporary supports, or shoulder closures. Ultimately, the inability to obtain funding will result in a safety risk to the public and the bridge will have to be closed. At the end of 2022, 69 local road agency bridges were closed due to condition - this is a 15% increase from the previous year and indicates further the added risk that Michigan's local road agency bridges are facing.



Figure 13

Source: 2022 National Bridge Inventory

Bridge Cycle of Life

Every year, analysts examine the bridge data to determine the extent to which bridges are improved or deteriorate over a 4-year span. This effort tracks how bridges change from the good, fair, and poor ratings and is referenced as the Bridge Cycle of Life.

Figure 14 shows over 5.2% more bridges have deteriorated than have been improved between 2019-2022.

In simplified terms, bridges are deteriorating faster than the agencies can repair or replace them.



Bridge Cycle of Life

All Roadway Bridges 2019-2022

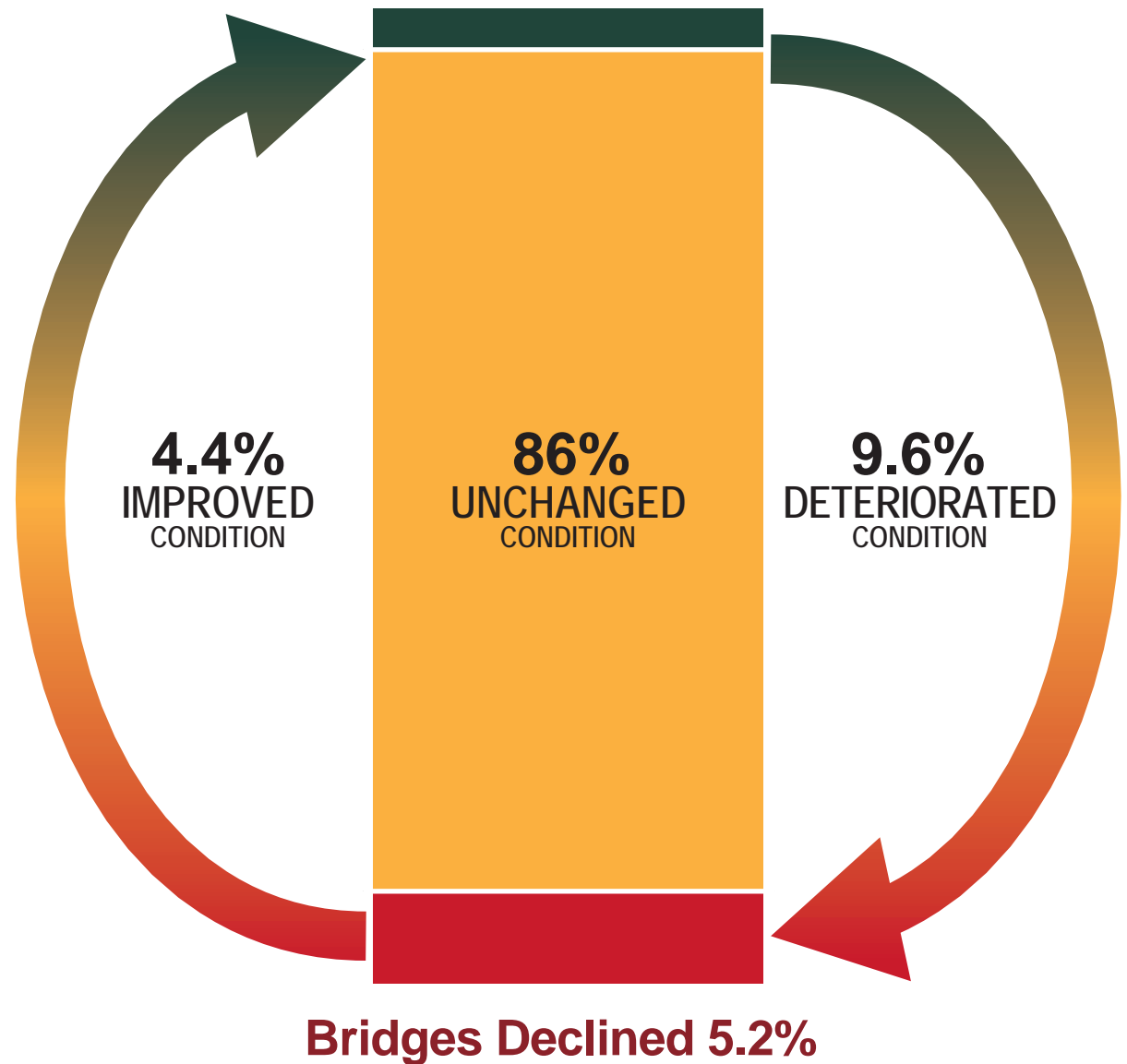
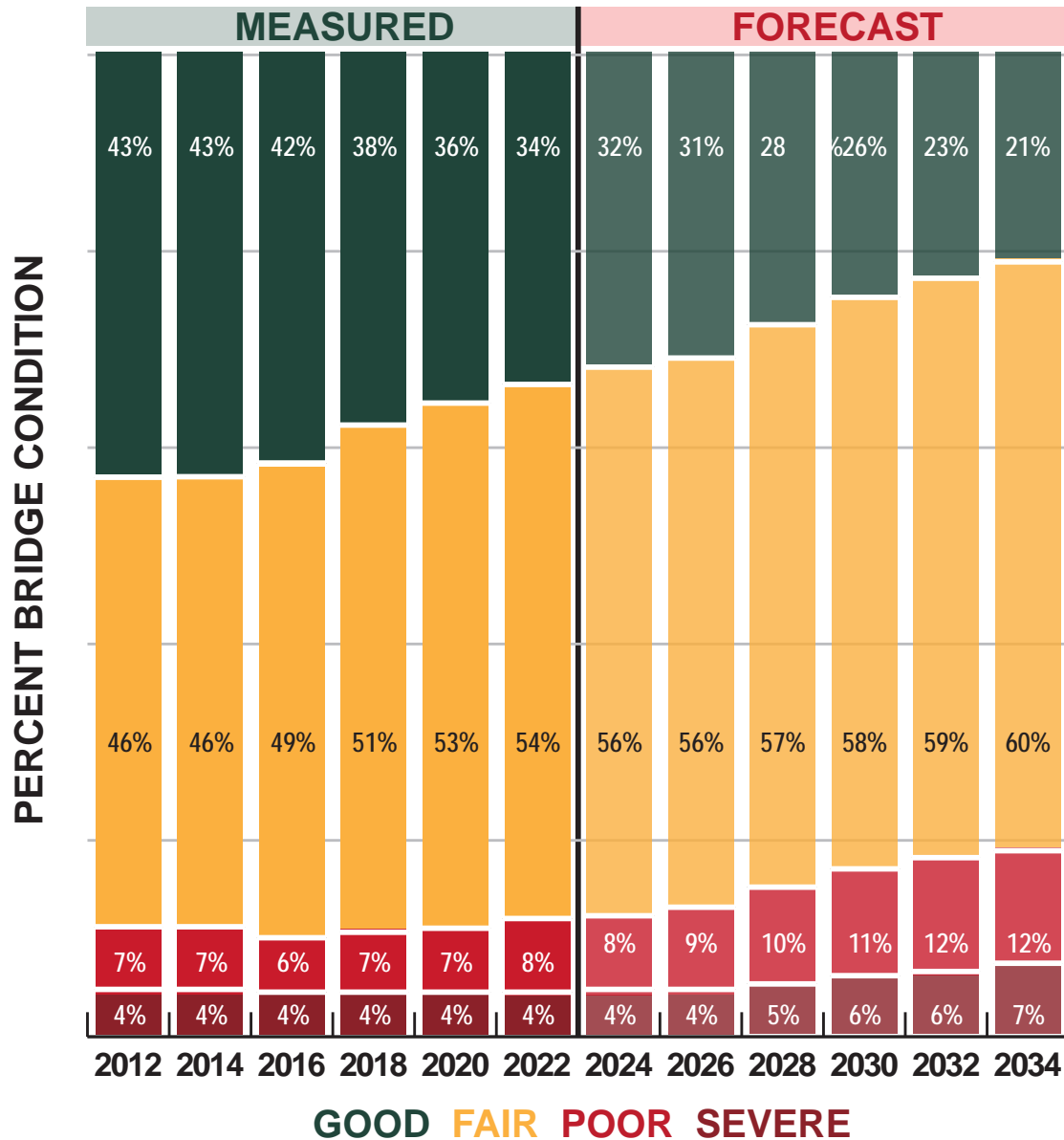

Figure 14

Source: 2019-2022 Michigan Bridge Inventory

Bridge Condition Forecast

2024-2034



Bridge Condition Forecast

Working from current NBI bridge condition information, bridge deterioration rate, project costs, expected inflation, and fix strategies, the Bridge Condition Forecasting System (BCFS) estimates future condition of bridges. Figure 15 indicates that the combined overall bridge condition of all Michigan's bridges is expected to continue to decline.

This analysis includes the bridge funding designated in IIJA for both trunkline and local agencies as well as other bridge program funds.

This forecast also includes the severe condition category that continues to rise. 19% of all bridges are forecast to be in the poor or severe category by the year 2034. This indicates that without additional investment for bridge programs additional bridges will be at high risk and lead to more emergency repairs and closures.



Figure 15

Source: 2022 TAMC



INVESTMENT REPORTING



Investment Reporting Tool (IRT)

The IRT is a free tool developed to allow all Michigan road owning agencies to satisfy the requirements of Act 51. The basic requirement is to report road and bridge projects they have completed and projects that are planned in the next three years. The IRT integrates with other software programs such as Roadsoft, Act 51 Distribution and Reporting System (ADARS) and JobNet to assist users in saving time and improving data quality and efficiency.

A road agency can also use the IRT as a tool to manage its road and bridge assets with customized maps, data exports, and a variety of summary reports. The interactive map in the IRT can display project information for presentations and public outreach.

Other IRT features include:

- Entering Traffic Signal Inventory Information (New Survey).
- Options to import major planned projects.
- Submission of warranties and transportation asset management plans.
- Project reporting options with Roadsoft software.
- PASER submission and review for planning agencies.
- Free training with online webinars, Help desk and YouTube videos.

What follows in this section are more details on the new traffic signal inventory survey along with road and bridge project summaries. This information is used in road and bridge condition forecasting efforts, statewide investment strategies and other initiatives.

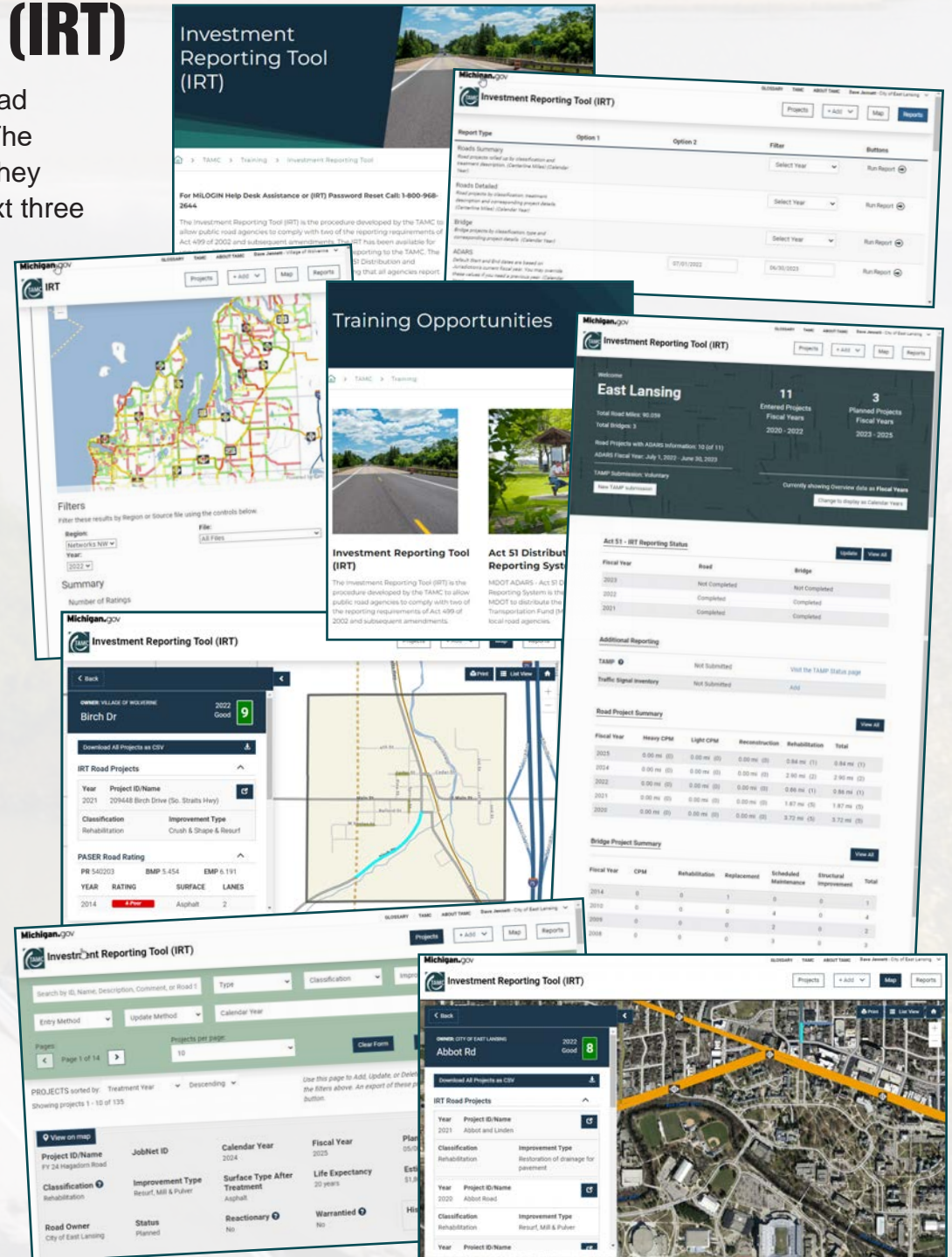



Traffic Signal Inventory Survey

Following the progress with inventory and condition data of roads, TAMC is now looking at traffic signals as another key transportation asset. This effort started in 2018 that involved multiple discussions with stakeholders across the state as traffic signals are owned and maintained in vastly different ways: one county may maintain signals for a city, or a different city may maintain the signals for several counties and villages in its nearby area or even a consulting firm. For some cities and villages, they may not own any signals with the primary traffic light being owned and maintained by a county or MDOT.

These partnerships often depend on who has the equipment and professional crews to support these assets.

The first step in trying to gain a better understanding of the scope of the asset class was inclusion of these assets as TAMP elements required for larger agencies. For a statewide broad effort, this

survey was added to the IRT investment reporting. The survey consists of asking several brief questions on who owns and maintains the signals for that road agency and any future planned investment in attempt to answer these questions:

1. The number of signalized intersections statewide.
2. The number of signalized intersections owned by villages, cities, counties, MDOT.
3. The annual cost to maintain signalized intersections on a statewide basis.
4. The annual cost to maintain signalized intersections by village, city, county, MDOT.
5. A source of detailed information about an agency's signalized intersections.
6. The number of signalized intersections maintained by MDOT, counties, cities, villages, and private contractors.
7. Significant expenditures anticipated in the next 3 years.

TAMC continues to incorporate user feedback to improve the survey and have statewide totals by Oct 1, 2023. *Note: the Traffic Signal Inventory Survey does not effect Act 51 funding.*

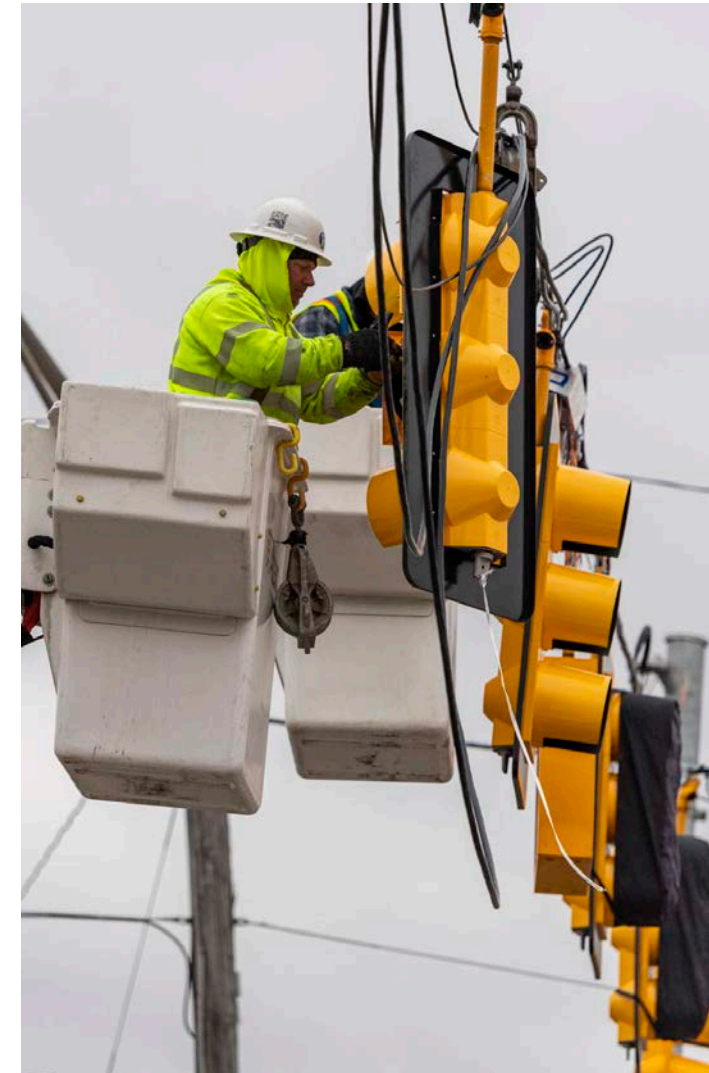



Road Project Details

Michigan has over 122,000 miles of public roads. These roads are owned collectively by 617 agencies consisting of 83 counties, 533 city/villages and the Michigan Department of Transportation. Although Michigan has one of the most complex road networks it also offers opportunities for collaboration and cost-savings through partnerships, open communication, and solid asset management planning. The dig once “motto” is the underlying theme in trying to balance multiple infrastructure efforts.

The IRT Road Projects are reported as these four classifications that assist in analysis and forecasting efforts:

- Reconstruction
- Rehabilitation
- Heavy CPM (Heavy Preventive Maintenance)
- Light CPM (Capital Preventive Maintenance)

As seen in Figure 16, 2020-2022 road projects submitted to the IRT total roughly \$4.79B of total investment over the last 3 years.

Road IRT Project Summaries			
Year	Projects Reported	Total Cost	Total Lane Miles
2020	5,342	\$1.63 Billion	18,210
2021	5,437	\$1.62 Billion	18,975
2022*	3,329*	\$1.54 Billion*	14,356*
Total:	14,108	\$4.79 Billion	51,541

Figure 16

Source: 2020-2022 TAMC

* IRT reporting is based on each agency’s Fiscal Year to sync with Act 51 financial reporting. This correlation is significant as many counties and cities have an annual 2022 reporting deadline of May or June, which is after this report is released. A more complete 2022 IRT data set will be available fall of 2023.



Bridge Project Details

Of Michigan's 617 road agencies, 352 own and maintain bridges. Approximately half of Michigan's 11,000 bridges are owned by local road agencies and the other half by MDOT. Bridge asset management considerations for individual road owning agencies can greatly impact planning and project considerations.

Bridges can vary substantially in their length, deck area and other factors. Replacing a bridge can often significantly impact the local economy as well as emergency services regardless of agency size.

As seen in Figure 17, investment in bridge projects ranged from \$191M to \$401M with roughly \$818M reported from 2020-2022. More costly bridge replacements contributed to the sharp increase in total cost for 2021.

Note: The Rouge River Bridge, Zilwaukee Bridge and other large bridges are not included in statewide totals, since the high cost of this type of project would significantly shift totals and averages.

Bridge IRT Project Summaries		
Year	Projects Reported	Total Cost
2020	337	\$226 Million
2021	308	\$401 Million
2022*	217*	\$191 Million*
Total:	862	\$818 Million

Figure 17

Source: 2020-2022 TAMC

* Full 2022 IRT data set available fall of 2023.



Michigan and Local Road Asset Management Across the Country

Statewide Local Road Asset Management

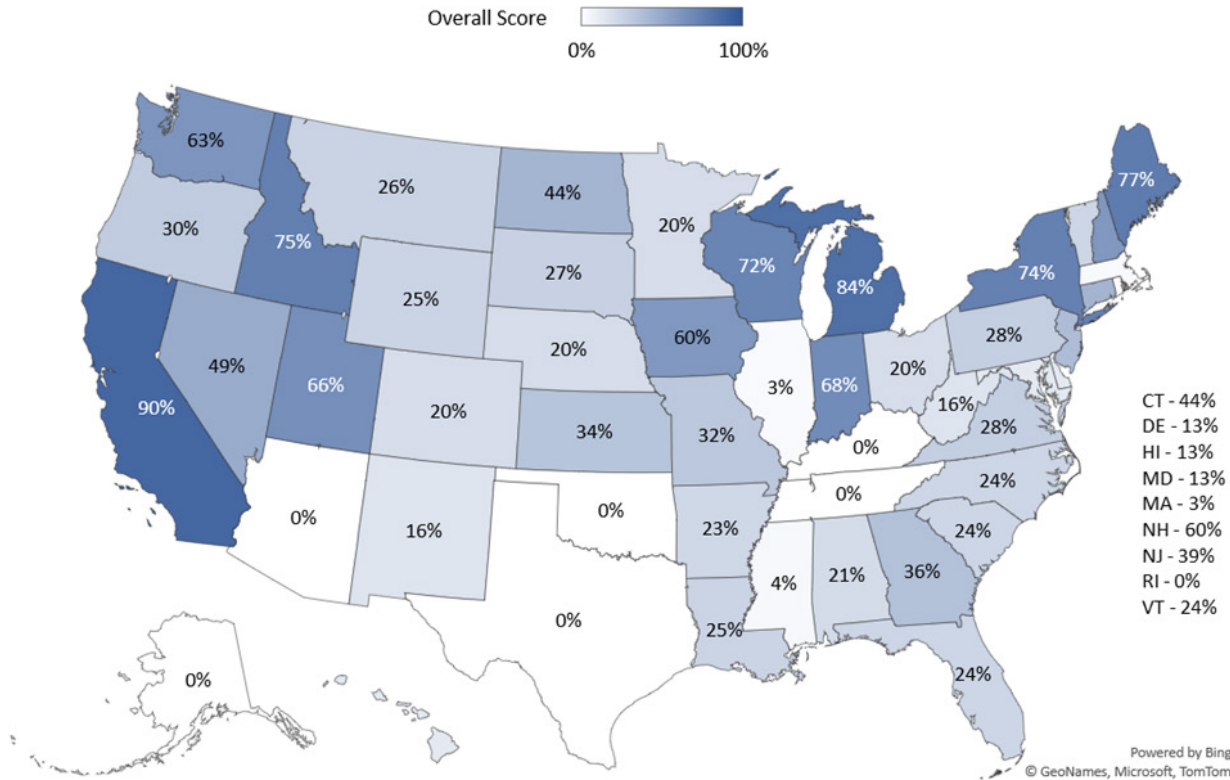

With TAMC being involved for over twenty years with asset management practices across the state, it's no surprise Michigan is one of the nation's leaders in local road asset management.

Every state is required to have a TAMP for the federal-aid system, however in Michigan we continue to be leaders in asset management beyond that system.

This report evaluated states on nine scoring measures that were then used to create an overall score.

As seen in figure 18, Michigan was second only to California in the study. Listed below are some of these measures, on whether a state's local roads had a statewide effort to:

- use a mix-of-fixes approach
- use preventive maintenance
- have a written plan
- assess needs
- include other road assets
- use ratings to determine fix

Figure 18

Source: 2023 Local Road Asset Management State of Practice Project Report

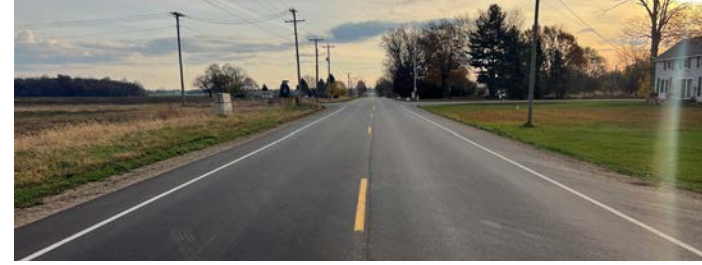

Figures 18 and 19 were taken from: **“Local Road Asset Management State of Practice Project Report”** by P. Torola, 2023, Center for Technology & Training.

Looking at figure 19, Michigan, California, and Indiana represent the only 3 states in the country with a statewide effort in written asset management plans for local roads based on trainings, tools, and regulatory reporting.

There were seven states that offered trainings, six states that offered tools, nine states that have some regulatory reporting requirements, and thirty-six states that offered nothing.

Solid asset management efforts need goals and resources to obtain them. Other report areas indicate funding needed to improve Michigan’s road and bridges is in the billions.

What are Michigan’s goals for road and bridge conditions and what would that cost be to the average person? TAMC continues to look at these questions with an expected statewide investment strategy in the fall.

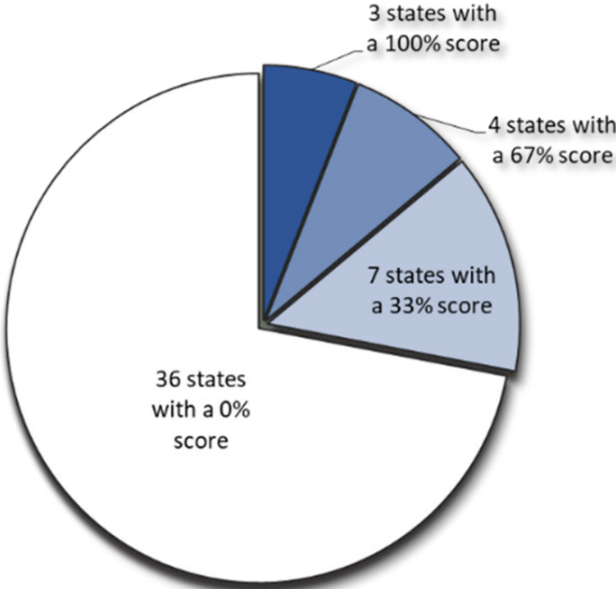
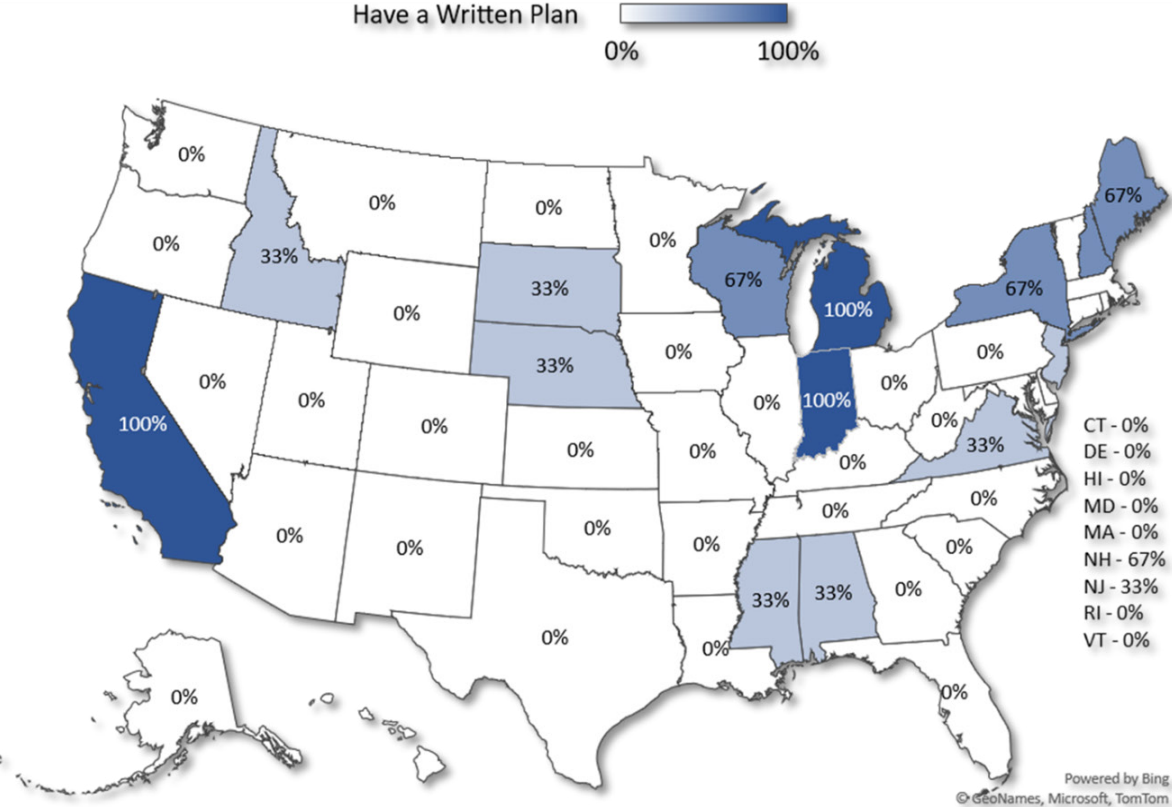

Figure 19

Source: 2023 Local Road Asset Management State of Practice Project Report

CELEBRATING 20 YEARS OF TAMC



Congratulations
TAMC
For 20 Years
of Service



20 YEARS

2008-2028
TAMC Michigan Transportation Asset Management Council

Celebrating 20 years!

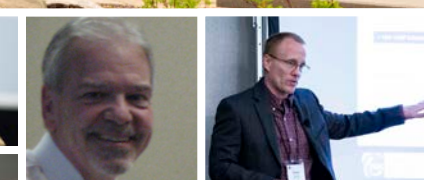
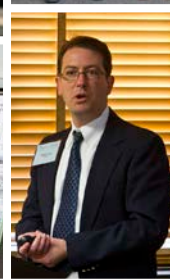

2002 TAMC created by Public Act (PA) 499 of 2002 – collaboration of cities, villages, counties, metropolitan planning agencies, townships and MDOT to report on Michigan roads and bridges.



2003 PASER regional pilot initiated. PASER chosen as the measure to identify pavement condition. (NBI used to measure bridge conditions nationwide)

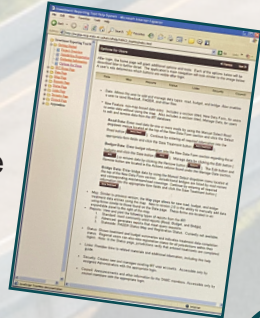

2004 First year of full PASER statewide road data collection.



2005 1st statewide PASER map created to show road condition across the state.



2008 First year of 50% PASER data collection and introduction of local road data collection.

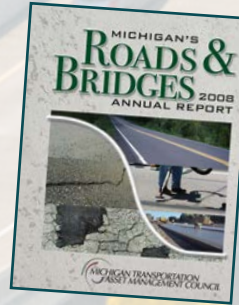

2007 First Interactive Map created for public to see PASER road conditions.



2006 IRT Investment Reporting Tool created to assist in average costs of road and bridge treatment types for forecasting. Wins award for Collaboration Technology and Partnerships.

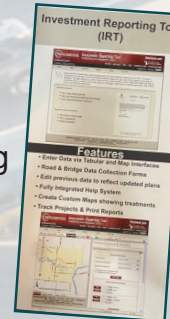

2009 IRT connected to Act 51 Reporting to improve data sets.

2010 Performance Metrics Dashboards created and made available to the public for roads and bridges.



2011 Michigan's Road Crisis Report: What will it Cost to Maintain Our Roads and Bridges? (State Rep Olsen and Schmidt.)

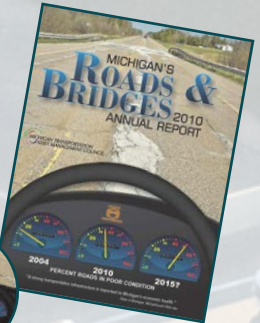

2012 TAMC Policy for Local Agency Act 51 Reporting Requirements Approved. First webinars introduced for IRT trainings. TAMC 10 Year Celebration.



2015

Added integration with Act 51 ADARS system to improve data quality and save time.

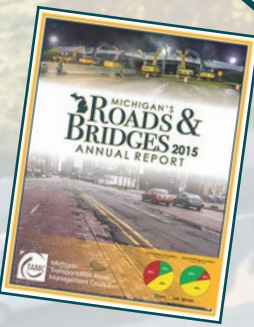

2014

Enforcement of IRT-Act 51 reporting begins as withholding of funds for those out of compliance Dashboards and Interactive Map fully mobile to be used with phones and tablets.



2013

Dashboards expanded to include Traffic, Safety, Maintenance and Finance that can be used by local agencies to assist in meeting required legislation for public dashboard.



2016

21st Century Infrastructure Commission created by Gov. Rick Snyder.

2017

First time pavements in Fair Condition equal those in Poor Condition at 40%. Gravel IBR Road rating system is developed. Michigan Infrastructure Asset Management Pilot Program partners with TAMC. IRT 2.0 released.



2018

Formation of the MIC. TAMP legislation passed, Culvert Pilot initiated and completed in a single year. First Year of IBR data collection. TAMC partners with APWA for joint conference.



2019

IRT - JobNet/STIP Integration. First year of severe category for bridges introduced, as Michigan leads Midwest in bridges in both poor and severe categories. TAMP training offered.

2022

20 Year Conference Celebration. IRT data used in bridge forecasting. TAMC website merged with MIC for added collaboration.



2021

Mission 100% PASER data collection Regional models for PASER forecasting. First time in 10 years road conditions show improved conditions.

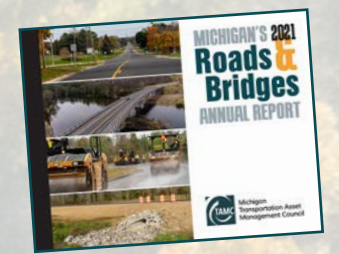

2020

First round of TAMPs due, PASER data collection reduced due to Covid-19

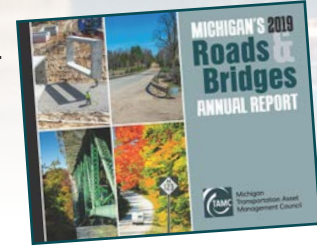
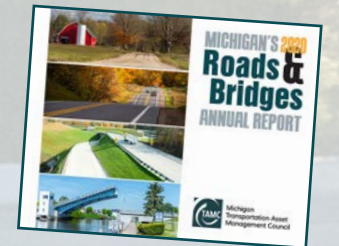

ACRONYMS AND ABBREVIATIONS

All references to Act 51 in this document refers to Public Act 51 of 1951, as amended.

ADARS: Act 51 Distribution and Reporting System

APWA: American Public Works Association

BCFS: Bridge Condition Forecasting System

CPM: Capital Preventive Maintenance

CRA: County Road Association (of Michigan)

CSS: Center for Shared Solutions (DTMB)

CTT: Center for Training and Technology (MTU)

DTMB: Department of Technology, Management and Budget

EGLE: Department of Environment, Great Lakes, and Energy

FHWA: Federal Highway Administration

FAST: Fixing America's Surface Transportation Act

IBR: Inventory Based Rating (Gravel Roads)

IJA: Infrastructure Investment and Jobs Act

IRT: Investment Reporting Tool

MAC: Michigan Association of Counties

MAR: Michigan Association of Regions

MDNR: Michigan Department of Natural Resources

MDOT: Michigan Department of Transportation

MIC: Michigan Infrastructure Council

MML: Michigan Municipal League

MPO: Metropolitan Planning Organization

MTA: Michigan Townships Association

MTPA: Michigan Transportation Planning Association

MTU: Michigan Technological University

NBI: National Bridge Inventory

NBIS: National Bridge Inspection Standards

NFC: National Functional Classification

NHS: National Highway System

PASER: Pavement Surface Evaluation and Rating

RPA: Regional Planning Agency

STIP: State Transportation Improvement Program

TAMC: Transportation Asset Management Council

TAMP: Transportation Asset Management Plan

WAMC: Water Asset Management Council

TAMC was created by Public Act (PA) 499 Of 2002

To act as a resource for independent objective data on the condition of Michigan's roads and bridges and a resource for implementing the concepts of asset management.





**“All public roads in Michigan will be managed
using the principles of asset management”**

- Public Act (PA) 499 of 2002 created the Michigan TAMC

Michigan.gov/TAMC